

Introducing

**The Highest Quality
Companion Crypt Private Mausoleum
in the Industry**

by *Everlasting*





1. Once the 4" thick granite back and sides are aligned, rebar supports are inserted to the back wall.



2. A stainless steel tie-rod is stretched across the length of the mausoleum for torsional strength.



3. The lower corners are reinforced with stainless steel angle irons.



4. Polystyrene, which provides greater strength and flex capability without increasing weight, is placed on the base prior to pouring the concrete floor.

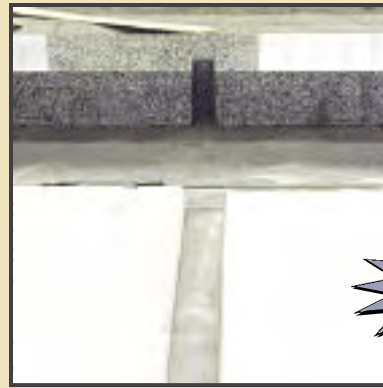

5. A 2" front notch is created to hold the granite divider in place securely.



6. A special epoxy is applied throughout fabrication. The same epoxy is used for stone cladding on newly constructed skyscrapers.

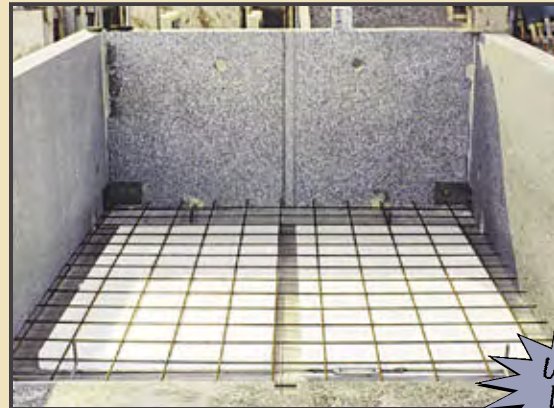

7. Stainless steel rebar welded together and inserted into the granite walls.



8. The 2" thick granite divider is placed in the front notch.





Unique Design

9. The granite divider is placed in the back notch to create two separate crypts.



Unique Design

10. Special epoxy is applied to the back wall of the mausoleum.



11. A stainless steel c-clamp is used to join the back and side walls.



12. A craftsman pours each side of the floor to a thickness of 6".



13. The cement floor is smoothed.



14. The floor is pitched toward drain holes.



15. The mausoleum is topped with a 6" thick granite roof and two vents are included on the back wall.



16. Two vents are included on each side of the mausoleum.



17. A front view of the mausoleum. Dimensions: 7-2 x 8-9 x 3-2
Additional Features: Two granite privacy doors are positioned inside the front shutter.

EVERLASTING combines the highest quality granite with superior design engineering to create one of the industry's most durable private mausoleums.

Everlasting Granite's new Companion Crypt Private Mausoleum is constructed from granite by master craftsmen.

- ▶ Well-built mausoleums
- ▶ Great attention to detail
- ▶ Competitively priced
- ▶ Two-crypt design
- ▶ Six beautiful colors – White Pearl, Rosa Beta, Spring Rose, Coral Blue, Jet Black and Paradisio.

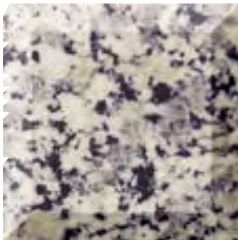

Rosa Beta

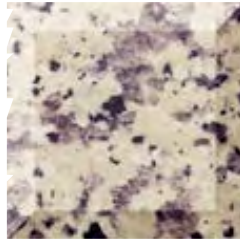

Spring Rose

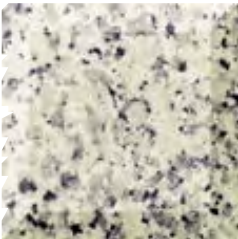

White Pearl

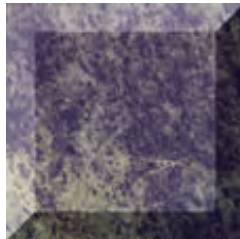

Coral Blue



Jet Black



Paradisio

TOP VIEW SPECIFICATIONS

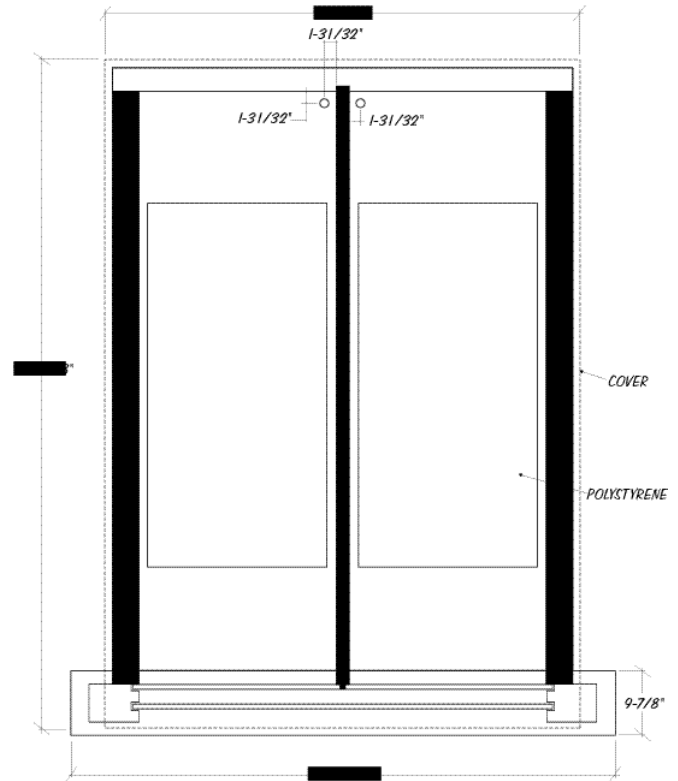

SIDE VIEW SPECIFICATIONS

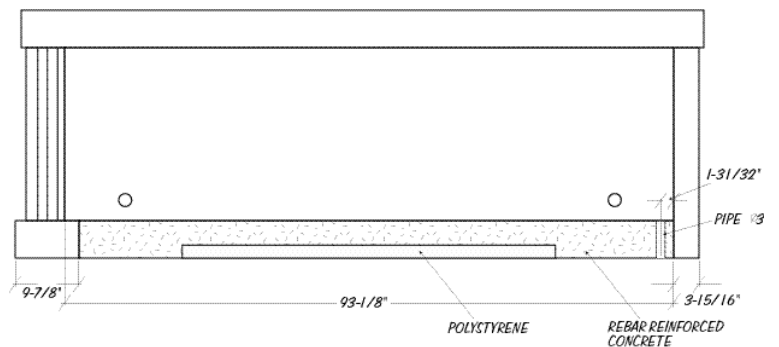

Serving Your Memorial Needs

P.O. Box 448 • Elberton, GA 30635 • 706-283-3704 • Toll Free 1-800-554-8407 • GA Toll Free 1-800-451-7626 • Fax: 706-283-3424